



MODEL *TERSUS 1200*
TERSUS 2000

AIR PURIFICATION SYSTEM



INSTALLATION AND OPERATION

GENERAL FILTERS, INC.

43800 Grand River Ave., Novi, Michigan 48375

Toll Free: (866) 476-5101 | Phone: (248) 476-5100 | Fax: (248) 349-2366

www.generalaire.com

TERSus Air Purification System

Table of Contents

Important Safety Instructions	1
Specifications	2
Operation	2-3
Cycle Times	2-3
Cost of Operation per Month	3
Service	3-4
Changing Filter	3-4
Changing UV Lamps	4
Resetting the Service Lights	4
Installation	5-6
Warranty	7
Performance Data	8
Electrical Schematic	9
Brand Decal Placement	9
Parts List	10

IMPORTANT SAFETY INSTRUCTIONS

Before installing the GeneralAire TERSus air purification system, inspect for any signs of damage. During handling and installation, **take care to protect the catalytic honeycomb side** of the product from physical damage, as the aluminum-titanium core is very soft and can be easily damaged.

Warning - Always unplug the power cord from the GeneralAire TERSus air purification system when changing the **filter** or ultraviolet lamps. Never look into a burning ultraviolet lamp without proper eye protection as severe damage to the eyes can result. This product is rated for standard ambient air temperatures during heating and air-conditioning functions and not rated for elevated air temperatures in excess of 125 degrees Fahrenheit.

Do not attempt to clean the **catalytic honeycomb core** with cleaning solutions. The catalyst is radiated with short wave ultraviolet light during periods of non-air flow and is self-cleaning.

Do not install insulation within 76MM or 3 inches of Luminaries.

Access for service is required when mounting above ceilings or behind walls.

Do not install in a position where the **interior model can gravity fall** from an elevated position and cause injury to the people or equipment below



SPECIFICATIONS

Model Tersus 1200:

(Capacity 1-1/2 to 3.0 tons)

MFG: GeneralAire

Model: TERSus1200

Power: 120V/60 Hz .6 Amps 49.2 Watts

Fuse: Replace only with AGC-2 fuse

Application: 3 Ton Drive Air Handler / Furnace

Max Face Velocity: 500 FPM

Max Air Flow: 1200 CFM

Service: U.V. Lamps - 1 year / Filter – 6/12 months

Replace: Only with LT016 UV lamps.

Replace: Filter with only FI018 MERV-13

U.V. Range: 254 NM (germicidal)

Catalyst: Metal Oxides 56 Sq. Feet

Weight: 23 LBS

Dimensions: 17” H x 25” W x 10” D

Model Tersus 2000:

(Capacity 4.0 to 5.0 tons)

MFG: GeneralAire

Model: TERSus2000

Power: 120V/60 Hz .6 Amps 49.2 Watts

Fuse: Replace only with AGC-2 fuse

Application: 5 Ton Drive Air Handler / Furnace

Max Face Velocity: 625 FPM

Max Air Flow: 2000 CFM

Service: U.V. Lamps - 1 year / Filter – 6/12 months

Replace: Only with LT016 UV lamps.

Replace: Filter with only FI016 MERV-13

U.V. Range: 254 NM (germicidal)

Catalyst: Metal Oxides 70 Sq. Feet

Weight: 26 LBS

Dimensions: 21” H x 25” W x 10” D

OPERATION

The GeneralAire TERSus air purification system installs in the air-inlet side of any heating and air-conditioning system up to five tons in size. Only operation of the air-handler fan unit is required for air purification and sterilization to take place.

Note: The ultraviolet lamps are wired to operate continuously. This feature allows the catalyst to burn off surface impurities, cleaning and reactivating itself during periods of non-use or no airflow. The cost of operation is less than .07 cents per day. See operating cost section.

The GeneralAire TERSus air purification system combines **three unique technologies** to protect people against indoor air pollutants. **Photo catalytic technology** (PCO) combined with high efficiency **electrostatic MERV13 particulate filtration** and **germicidal ultraviolet light** quickly reduces and eliminated toxic gas-phase chemicals, lung damaging dust and airborne germs from the living environment.

Many new homes have smart programmable thermostats that allow for automatic operation of the air-handler fan unit when there is no demand for heating or air conditioning. It is **important that the GeneralAire TERSus air purification system is operating at least 30 minutes per hour (24) hours per day** to remove toxic materials from the indoor environment.

The length of operation depends on the location of the home or office in relation to point source pollution such as refineries, processing plants, automobile traffic and areas that produce high levels of pollen. Individuals that are sensitive to mold spores, dust mites, chemicals or have respiratory problems such as asthma, emphysema, and chronic allergies should extend the run time to (40) minutes or more per hour.

AIR CYCLES PER HOUR

(Based on 3000 sq. ft.)

Fan unit on for 10 minutes per hour
Fan unit on for 15 minutes per hour
Fan unit on for 20 minutes per hour
Fan unit on for 30 minutes per hour

Air cycled(1) ----- times per hour
Air cycled(1.3) ----- times per hour
Air cycled(1.75) ---- times per hour
Air cycled(2.62) ---- times per hour



OPERATION CONTINUED

AIR CYCLES PER DAY

Fan unit on for 10 minutes per hour	Air cycled(24) ----- times per day
Fan unit on for 15 minutes per hour	Air cycled(31) ----- times per day
Fan unit on for 20 minutes per hour	Air cycled(42) ----- times per day
Fan unit on for 30 minutes per hour	Air cycled(63) ----- times per day

Note: In the event, the existing thermostat does not have the capability to operate the air-handler fan unit independently of a demand for heating or air-conditioning, it is highly recommended that an (AirCycler) be installed.

This device is simply wired in parallel with the existing thermostat wire and can be programmed to turn on the air handler fan unit for any desired interval. A memory tracks the time the fan unit operates every hour and only cycles the fan unit that hour if normal requirements for heating and air conditioning have not cycled the fan unit long enough to meet air purification requirements.

COST OF CONTINUOUS (24) HR PER DAY OPERATION PER MONTH

Electricity cost			
<i>per kilowatt hour</i>	.06 kw hr.	.08 kw hr.	.10 kw hr.
Tersus (32.25 kw hours)			
<i>per month</i> =	\$1.93	\$2.58	#3.22

During periods where the fan unit is being operated for the sole purpose of air purification, usually during the spring and fall season when there is no requirement for heating or cooling, the cost of running a 1/2 horsepower fan unit will add approximately \$5.36 per month to the normal operating cost. However, this cost is easily offset in savings on medication, doctors office visits, mechanical maintenance and cleaning of fan units, refrigeration coils, dirty air ducts and last but not least, less house cleaning.

SERVICE

The GeneralAire TERSus 1200/2000 comes with a built-in computer to automatically keep track of service intervals. Indicator lights will tell you when to change filter and ultraviolet lamps (30) days in advance.

MERV13 Filter change every (6 to 12) months service light turns from green to yellow after five months and to red after six months.

Ultraviolet Lamps change every (12) months service light turns from green to yellow after eleven months and to red after twelve months.

CHANGING THE FILTER

1. Unplug the power cord from the GeneralAire TERSus air purification system. Unscrew the two locking knobs and remove the door. (Fig. 1)
2. Remove old filter and replace with new filter. Make sure airflow arrow on filter is pointing to the inside of module. (Fig. 2)

FIG. 1

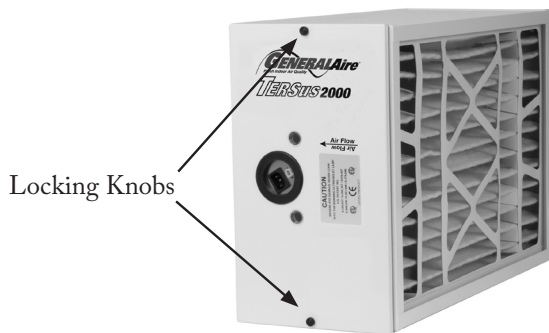

Locking Knobs

FIG. 2



CHANGING THE UV LAMPS

1. Unplug the power cord from the GeneralAire TERSus air purification system. Unscrew the two locking knobs and remove the door. (Fig. 3)
2. Remove Photocatalytic module. (Fig. 4)
3. Unplug UV lights, loosen retaining knobs, and remove UV lights. (Fig. 5, 6)
4. Replace UV Lights, re-tension retaining knobs, and replace plug-ins.
5. Replace Photocatalytic module and filter, secure door and re-insert power cord, check sight ports to ensure lamp illumination.

Note! Ensure filter and photocatalytic module are installed in proper air flow sequence.

FIG. 3

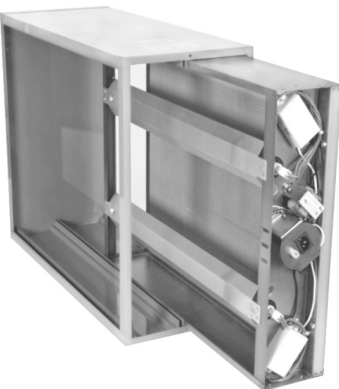
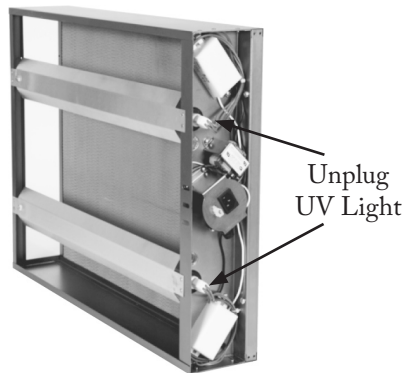
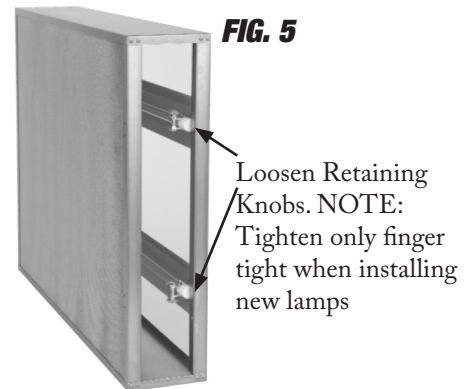

FIG. 4



Unplug
UV Light

FIG. 5



Loosen Retaining
Knobs. NOTE:
Tighten only finger
tight when installing
new lamps

RESETTING SERVICE LIGHTS

On the right side of the service panel, there are arrows pointing to two small holes marked reset. One marked **filter** and one marked **lamp**. Using a small paper clip, bend out one leg straight and insert the end of the paper clip into **only** the hole corresponding to the replaced component and push lightly until the service light returns to the green position. The computer is now reset.

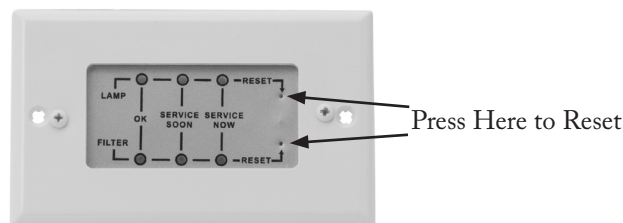

FOR REPLACEMENT FILTERS AND ULTRAVIOLET LAMPS

Contact your local HVAC wholesaler or contractor. Or call, General Filters, Inc., 43800 Grand River Ave., Novi, MI 48375 at 866-476-5101.

INSTALLATION

Make sure to install the GeneralAire TERSus air purification system so that the inlet or return air enters the side containing the MERV13 particle filter first.



TYPICAL VERTICAL AND HORIZONTAL INSTALLATION

1. Unscrew the two locking knobs and remove the inside module from the outer case.
2. Take care not to bend or distort the outer metal enclosure.
3. Mount the outer case to the support plenum. **Note: Do not use a screw length that will extend into or penetrate the inside module containing the catalyst or filter.**
4. In some cases the foot print of the air handler may be larger or smaller than the outer enclosure of the Tersus Unit. A metal adapter plate of 18 ga. metal should be fabricated to make a suitable transition. (Fig. 7)

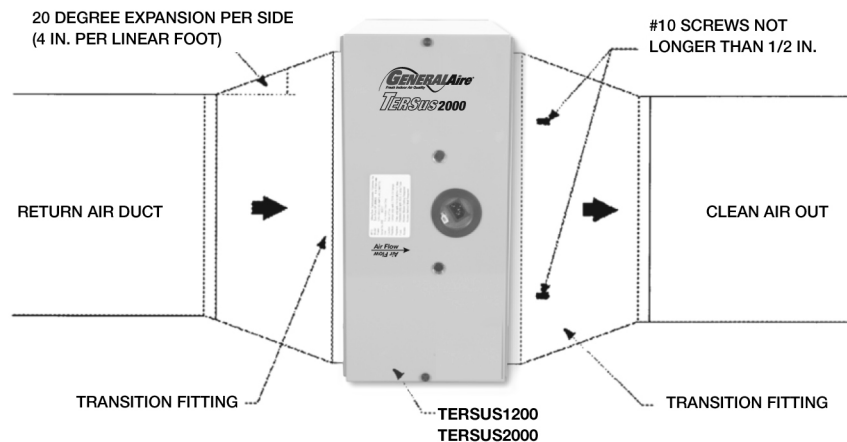

FIG. 7
TRANSITIONS FOR IN-DUCT MOUNTING

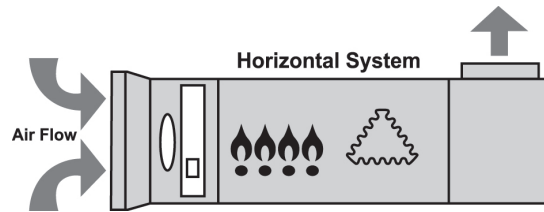

FIG. 8

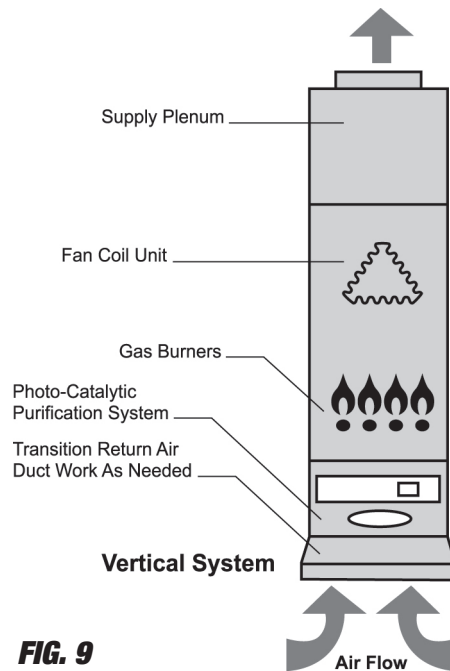

FIG. 9

5. Tape all seams between the air handler and the outlet side of the GeneralAire TERSus 1200/2000 so that there can be no air bypassing the system.
6. Attach the air handler to the outlet side of the GeneralAire TERSus 1200/2000 and fasten with #10 x 3/8 self-drilling sheet metal screws. **Note:** only 1/2 inch of clearance has been provided between the outer and inner case.
7. Slide the inner module into the outer encasement and tighten locking knobs finger tight. Make sure the inner module will freely slide in and out of the outside enclosure.
8. Plug in the power cord to any **120vac outlet** and check both sight ports to make sure both lamps are illuminated. Ultraviolet lamps must **remain on** at all times regardless of thermostat or AirCycler settings.
9. Check the service panel. The LED lights should be flashing in sequence for a 15 second period of time and then return to green. The filter lamp should be **flashing green** and the UV lamp light should be a **steady green**.
10. Set the thermostat or the AirCycler to operate the fan unit for at least **30 minutes every hour**. If air quality problems persist after one week, increase the fan unit operating time by (5) minute intervals.



5 YEAR LIMITED WARRANTY

The TERSus1200 and TERSus2000 is delivered to you with a GeneralAire Five Year Limited Warranty. The MERV13 High Efficiency Filter Media is an expendable service item that is not covered under this warranty. The MERV13 Filter Media is recommended to be changed every 6 to 12 months as needed per your HVAC equipment operation. Serviceable replacement UVC Lamps are covered with a one year warranty free from defects or premature failure for a period of one year from the date of purchase. The UVC Lamps are recommended to be replaced annually for optimum performance. GeneralAire manufactures and distributes the TERSus1200 and TERSus2000 and is not responsible for installation of this product.

This warranty does not cover faulty installation or damage to personal property resulting from incorrect or faulty installation. This warranty does not cover the cost of removal or reinstallation of the TERSus1200 and TERSus2000. This warranty does not cover labor for service or any warranty work that may be deemed necessary. All warranty repair work must be performed by a qualified service HVAC Contractor. Any shipping costs that may apply are the responsibility of the owner of the TERSus1200 and TERSus2000.

This warranty is provided to the original purchaser of the TERSus1200 and TERSus2000 and may not be transferred, sold or bartered. This product is not warranted against freight damage, failure resulting from misuse, connection to incorrect voltage, or acts of God such as fires, earthquakes, or floods.

You may register your warranty online at www.generalaire.com or detach form below and mail to General Filters, Inc., Attention Warranty Department, 43800 Grand River Ave., Novi, MI 48375

WARRANTY REGISTRATION

Product Information:

Serial Number: _____

Model: _____

Install Date: Month _____ Day _____ Year _____

Owner Information:

Name: _____

Address: _____

Address2: _____

City _____ State _____ Zip Code _____

Phone: _____

Email Address: _____

Contractor Information:

Name: _____

Address: _____

Address2: _____

City _____ State _____ Zip Code _____

Contractor Phone: _____

Contractor Email Address: _____

PERFORMANCE DATA

TERSUS PERFORMANCE DATA AND APPROVALS:

For TERSus1200 1^{1/2} - 3 Ton Drive Systems

Air Flow & Resistance Data At MERV13:	Air Flow (cfm)	Resistance (in w.g.)	Air Velocity (fpm)
	400	0.09	144
	800	0.18	288
	1200	0.30	433
	1600	0.38	577

For TERSus2000 3^{1/2} - 5 Ton Drive Systems

Air Flow & Resistance Data At MERV13:	Air Flow (cfm)	Resistance (in w.g.)	Air Velocity (fpm)
	1000	0.18	288
	1500	0.30	432
	2000	0.38	576
	2500	0.50	720

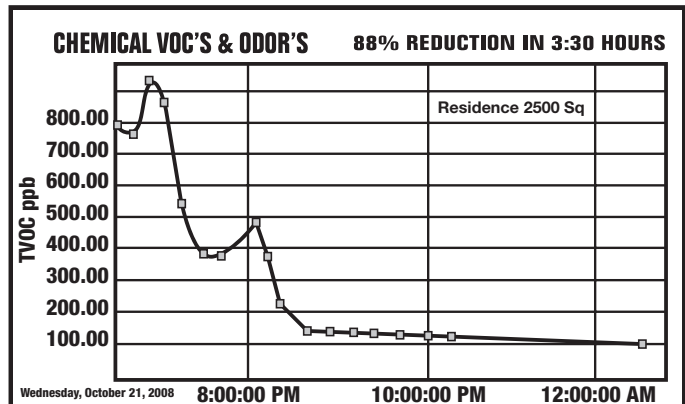
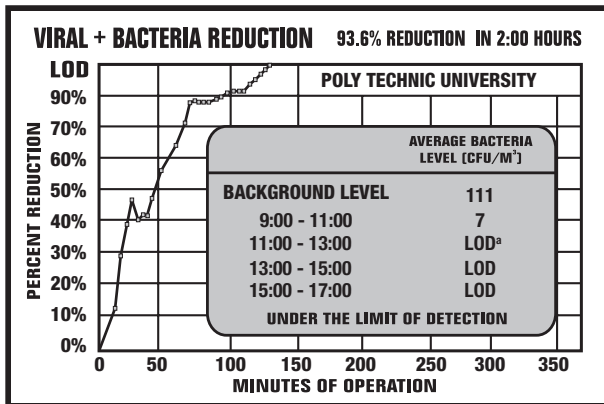
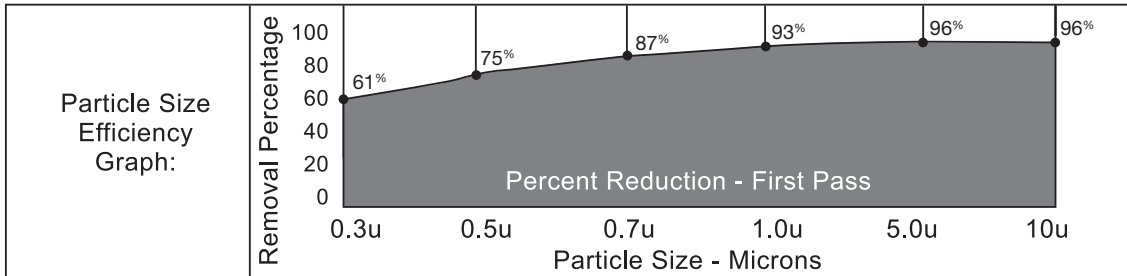

Removal Efficiency Of Typical Allergens

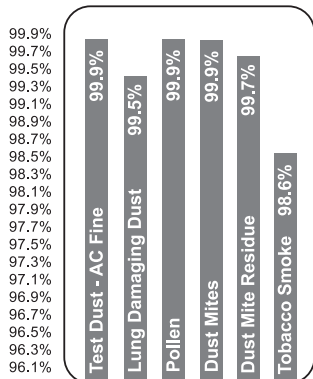

ELECTRICAL TESTING LABORATORIES
UNITED STATES



ELECTRICAL TESTING LABORATORIES
CANADA

WIRING DIAGRAM

MODEL TERSUS1200 & TERSUS2000

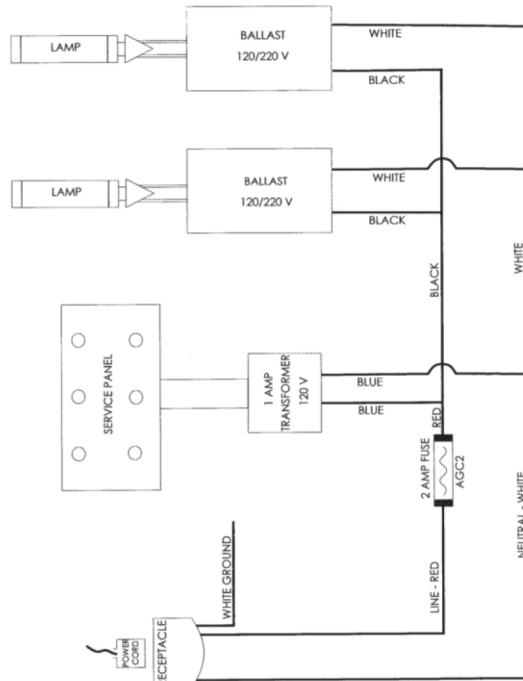
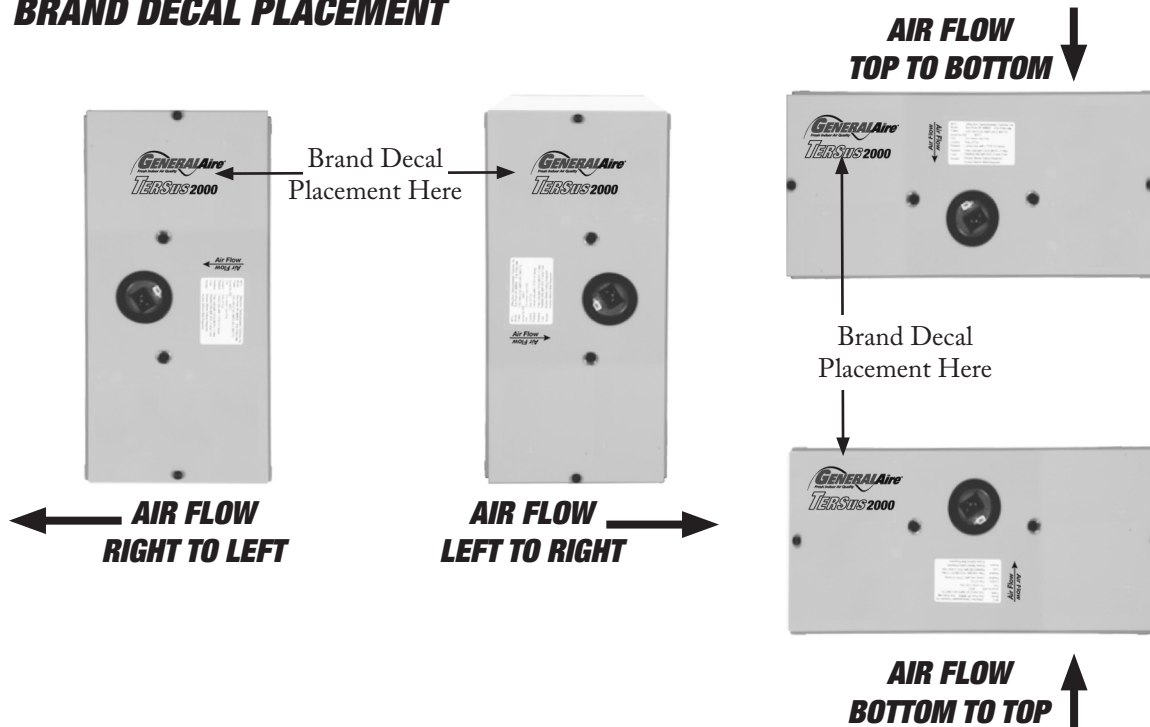
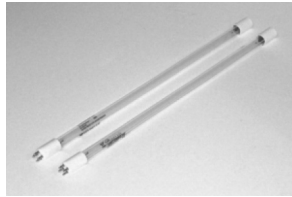

Fig. 10 ELECTRICAL DIAGRAM

BRAND DECAL PLACEMENT



TERSUS1200 / TERSUS 2000 AIR PURIFICATION PARTS LIST



Replacement UV Lamp (2 Required)
for TERSus1200 and TERSus2000

Part Number	GFI #
LT016	4564

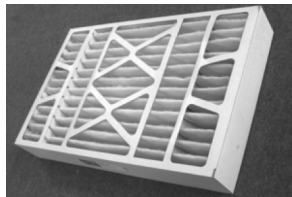

Replacement MERV13 Electrostatic Filter
for TERSus1200
for TERSus2000

Part Number	GFI #
FI021	4572
FI020	4562

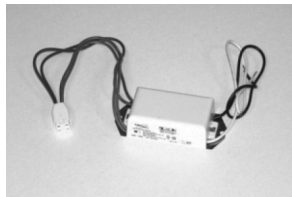

Electronic Lamp Ballast
for TERSus1200 and TERSus2000

Part Number	GFI #
BL014	4565

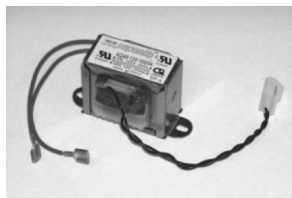

12 Volt Transformer
for TERSus1200 and TERSus2000

Part Number	GFI #
BL007	4566

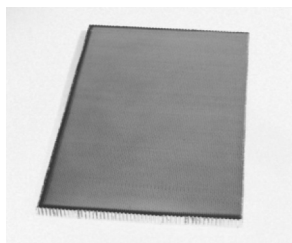

Titanium/Honeycomb Catalyst
for TERSus1200
for TERSus2000

Part Number	GFI #
AL004	4573
AL006	4563



GENERAL FILTERS, INC.

43800 Grand River Ave., Novi, Michigan 48375

Toll Free: (866) 476-5101

Phone: (248) 476-5100

Fax: (248) 349-2366

www.generalaire.com

CANADIAN GENERAL FILTERS, LTD.

400 Midwest Rd., Toronto, ON M1P 3A9

Toll Free: (866) 476-5101

Phone: (416) 757-3691

Fax: (416) 757-4687

www.cgfproducts.com